



**YANMAR**

**YANMAR** YT347/359 & Attachments



2022 · 2021 · 2020 · 2019 · 2018  
EQUIPMENT DEALERS ASSOCIATION  
SURVEY | TRACTOR MANUFACTURERS

**PRODUCT  
QUALITY**

**YT347/359**



**HISTORY**

**1912**

**Over 100 years of history.** Founded as Yamaoka Hatsudoki Kosakusho, a company with a mission to build the most reliable, compact and efficient engines for farmers, fishermen and other trades and businesses.

**1933**

**83 years of diesel engines.** Developed the world's first commercially successful small horizontal water-cooled diesel engine with a cold-start system.

**1967**

**The first YANMAR tractor.** From the beginning, YANMAR tractors like the 23 horsepower Model YM273 use YANMAR water-cooled diesel engines.

**1979**

YANMAR Tractor (USA) Inc. begins operations in North America.

LOVE  
YOUR LAND  
**LOVE**  
**YOUR YANMAR**

We each have our own unique relationship to the land. Some of us tend to its creatures. Some of us rely on it for food. And some of us just enjoy basking in its endlessly evolving beauty. What we all share is a common dedication to the soil and a commitment to put back into it more than we take out of it.

This love of the land and a passion for the environment has guided YANMAR for more than 100 years. Our story began with one simple and powerful tenet: "To conserve fuel is to serve mankind."

Our commitment to the planet and our dedication to serving all of you who serve the land has never been more evident than in our new line of YT compact utility tractors.

**1992**

**Millions of diesels.** The 10 millionth YANMAR diesel engine is produced and sold.

**2006**

**Advancing tractor technology.** The first generation of HMT (hydromechanical transmission) technology for YANMAR tractors is introduced.

**2016**

YANMAR launches the YT Series tractors with i-HMT, the most efficient, powerful and productive line in its 104-year history.

**2017**

YANMAR EVO//CENTER opens Fall 2017, YANMAR America training and customer experience facility in Acworth, Georgia.



**YT347 OPEN PLATFORM TRACTOR,  
LOADER, AND ROTARY CUTTER**



Engine

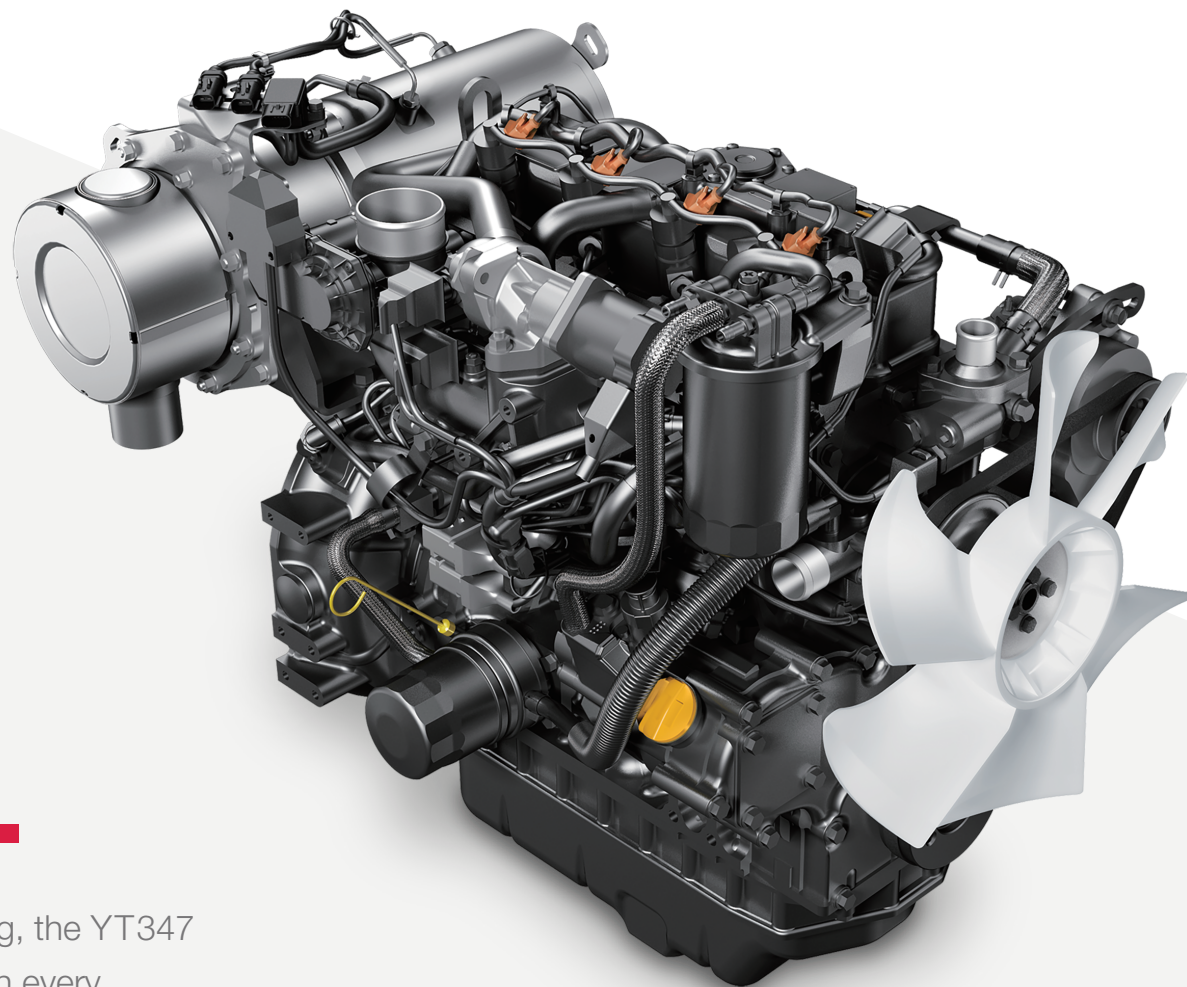

# Love your **efficiency.**

Whether a simple job or a complex dig, the YT347 and YT359 have you covered. As with every YANMAR tractor, the true beauty lies in the engine.

# FOUNDER'S SPIRIT: “TO CONSERVE FUEL IS TO SERVE MANKIND.”

Magokichi Yamaoka, Founder of YANMAR



2022 • 2021 • 2020 • 2019 • 2018

EQUIPMENT DEALERS ASSOCIATION  
SURVEY | TRACTOR MANUFACTURERS

**PRODUCT  
QUALITY**

## The Environmental Engine

In 1996, YANMAR was the first manufacturer to have a diesel engine certified under the EPA process. Today's new emissions standards are much more rigorous, requiring a 90 percent reduction in particulate matter compared to the previous measure. YANMAR diesel engines, besides being extremely powerful and efficient, are exceptionally clean and quiet. In fact, the engines in our YT line far surpass Tier 4 EPA mandates. It's simply part of YANMAR's history of innovation and commitment to producing the highest-quality engines and our proven commitment to serving the sustainability of the land.

## Strength and Efficiency

Our four-cylinder liquid-cooled diesel engines rely on innovative fuel-injection systems and combustion chambers to create an unbeatable level of power and efficiency. The result is more power to get through the heaviest load, and more efficiency to get every job done on less fuel.



YANMAR

**YT359 WITH FACTORY-INSTALLED  
CAB WITH HEAT & A/C, GRAPPLE**



# PERFORMANCE LINK DRIVETRAIN FROM YANMAR

## i-HMT Transmission

No other compact tractor can boast the Integrated Hydro Mechanical Transmission technology of the YT347 and YT359. The i-HMT transmission creates a new standard of operation for more versatile performance. No longer do you have to choose between an efficient, constant speed and flexible operation. With the i-HMT transmission, you get both.

### The i-HMT Provides:

- Efficient conversion of horsepower into PTO horsepower and drawbar horsepower
- Ability to choose the right speed for every task and application
- Low fuel consumption due to increased efficiency
- Stepless main shift
- Clutchless shifting
- Vehicle stop without clutch

## Auto Throttle

Engine and travel speed can be controlled with the accelerator/drive pedal.

## AB Mode

Control your engine speed and ground speed with AB Mode. AB Mode allows you to preset your maximum speed when the i-HMT pedal is fully engaged.

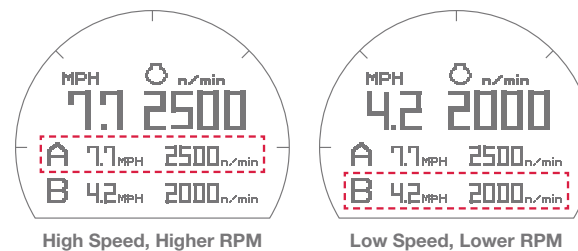

## Other Features Provided by i-HMT

- Anti-stall
- Cruise control
- i-HMT motion control dial

## i-HMT Mechanical Efficiency Hydrostatic Productivity

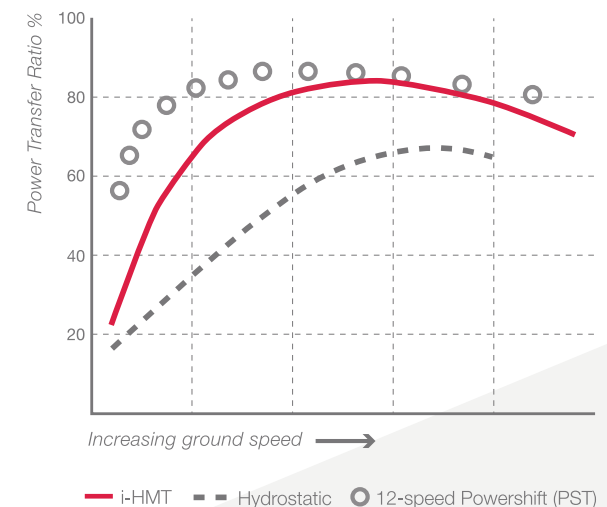

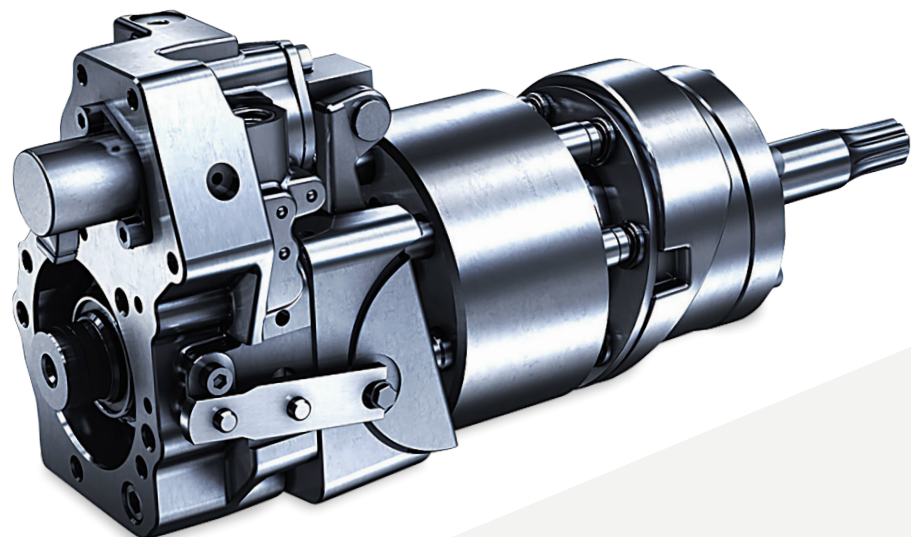

## Love your **reliability.**

Harmony with the land begins with the harmonious relationship between engine, transmission and axles. YANMAR produces all major drivetrain components in-house to ensure perfect fit, balance and overall reliability. We call it Performance Link Technology, and it's why every YANMAR tractor—including the YT series—delivers a smoother, more comfortable ride with less noise, more horsepower and more efficiency.



**YT347 OPEN PLATFORM  
TRACTOR WITH LOADER**



YT347/359

Love your  
**YANMAR**

Introducing the  
YT347 and YT359.



# POWERFUL BY DESIGN



- Dual rear remote valves are standard equipment
- Tractor style draw-bar (standard)
- Tire availability (R1 Ag, R3 Turf, R4 Industrial)
- Continuous Live Independent PTO

## Bold and Modern Style

Every version of the YT347 and YT359 offers a clean, bold and modern style while maintaining the highly efficient engineering and craftsmanship that have defined YANMAR for more than a century. From the first glance through the first drive, the YT line delivers an experience that's as captivating as it is effective.

## Technological Superiority

The advanced design of the YT line is only the beginning. The YT347 and YT359 models are both built to help you be more efficient and therefore more productive every day. From in-cab controls to under-the-hood engineering, the innovation of the YT3 tractors goes much deeper than stunning aesthetics.







**YT347 OPEN PLATFORM TRACTOR,  
LOADER, AND ROTARY CUTTER**



# THE COMFORT CAB



Fingertip forward/reverse control



Full LCD display with electronic controls



Tilt steering



Flat, walk-through floor and large, anti-slip step

## Love your productivity.

The optional cab on our YT line creates a new level of comfort with heat and air conditioning both sealed in. The tight-closing, air-filter-equipped cab helps keep out dust. The isolated platform design decreases vibration thereby reducing operator fatigue. Visibility has been improved with an innovative curved glass windshield. The deluxe seats with armrests recline for added comfort. There's even a convenient operator's manual storage. Every detail has been considered not just for your physical comfort, but for your optimum productivity and efficiency. With YANMAR, comfort is never a tradeoff with productivity.



**YT359 WITH FACTORY-INSTALLED  
CAB WITH HEAT & A/C, FRONT  
AND REAR BALE SPEAR**



## Attachments

# Love your versatility.

There's a tool for every job, every day of every season. The entire YT line is strategically engineered with the attachment use in mind, never as an afterthought. For this reason, YANMAR designs, builds and tests our equipment right at our U.S. headquarters in Adairsville, Georgia, demonstrating our commitment to a more versatile, user-friendly operation.

### Loader Attachments

The newly designed auto stand system for easy mounting and dismounting is standard on all YT model loaders. In addition, the industry-standard, skid-steer-style loader quick attachment systems allow for easy use of a wide array of loader attachments such as:

- Pallet forks
- Bale spears

### Operate these attachments with optional loader 3rd function kit:

- Grapple
- Bale squeeze
- Power angle blade

### Operate these SSL\* attachments with optional auxiliary hydraulic pump kit:

- Snow blower
- Rotary broom



\*Skid steer loader

# YEAR-ROUND PERFORMANCE

## Optional Rear Attachments

- Landscape rakes
- Rear blades
- Rotary tillers
- Grading scrapers and box blades
- Disc harrows
- Stump grinder
- Quick hitch
- Rotary cutters
- Finish mowers
- Post hole digger
- Precision seeder



## B90 Backhoe

Digging depth (2' flat bottom)	109"
Swing arc	180°
Bucket cylinder digging force	5,070 lbf
Dipper stick cylinder digging force	2,900 lbf
Bucket widths	12"– 36"
Hydraulic thumb kit (optional)	
Mechanical thumb kit (optional)	



**YT359 WITH FACTORY-INSTALLED  
CAB WITH HEAT & A/C, LOADER,  
AND ROTARY TILLER**



# YT347/359

Powertrain	YT347 (i-HMT)		YT359 (i-HMT)	
	ROPS	CAB	ROPS	CAB
Maker	YANMAR		YANMAR	
Model	4TNV88C (Tier 4)		4TNV98C (Tier 4)	
Gross power	46.0 HP (34.3 kW)*		58.9 HP (43.9 kW)*	
PTO power at working speed	39.5 HP (29.1 kW)		52.0 HP (38.3 kW)	
PTO power at 0 speed	36.4 HP (26.8 kW)		48.9 HP (36.0 kW)	
Rated RPM	2,800 RPM		2,500 RPM	
Bore and stroke	3.46 x 3.54 in. (88 x 90 mm)		3.86 x 3.94 in. (98 x 110 mm)	
Total displacement	133.5 cu. in. (2.189 L)		202.5 cu. in. (3.318 L)	
Combustion system	Common Rail Direct Injection		Common Rail Direct Injection	
Air cleaner	Dual Stage Cyclonic (resin 5.5")		Dual Stage Cyclonic (resin 6.5")	
Aspiration	Naturally aspirated		Naturally aspirated	
Cooling system	Liquid cooled		Liquid cooled	
Number of cylinders	4		4	
Battery	650 CCA		880 CCA	
Alternator	12-55		12-55	

## Dimensions

	75.9" (1927 mm)	75.9" (1927 mm)	77.4" (1967 mm)	77.4" (1967 mm)
Wheelbase				
Width (with R4 tires)	70.6" (1793 mm)	70.6" (1793 mm)	70.6" (1793 mm)	70.6" (1793 mm)
Overall length (with 3PH and R4 tires)	130.9" (3325 mm)	130.9" (3325 mm)	132.1" (3355 mm)	132.1" (3355 mm)
Overall height (with R4 tires)	95.7" (2431 mm)	89.5" (2274 mm)	95.7" (2431 mm)	89.5" (2274 mm)
Ground clearance (with R4 tires)	12.8" (326 mm)	12.8" (326 mm)	12.8" (326 mm)	12.8" (326 mm)
Weight (with ROPS, R4 tires, full fluid)	3,880 lbs. (1760 kg)	4,284 lbs. (1943 kg)	4,039 lbs. (1832 kg)	4,442 lbs. (2015 kg)

\*As rated by engine manufacturer. Values published are for descriptive purposes only and YANMAR reserves the right to change the values.

Capacities	YT347 (i-HMT)		YT359 (i-HMT)	
	ROPS	CAB	ROPS	CAB
Fuel tank	12.7 gal. (48 L)		12.7 gal. (48 L)	
Cooling system	6.2 qt. (5.9 L)		7.8 qt. (7.4 L)	
Engine oil	7.0 qt. (6.6 L)		8.0 qt. (7.6 L)	
Transmission case	7.7 gal. (29 L)		7.7 gal. (29 L)	
Front axle	2.4 gal. (9 L)		2.4 gal. (9 L)	

## Drivetrain

Transmission type	i-HMT
Rear differential lock	Foot pedal engagement
2WD/4WD engagement	Selectable
Brakes	Mechanical wet disc
Reverser	Powershift
Number of ranges	3 Range (variable speed)
Rear PTO/RPM	540 RPM

## Hydraulics

Pump capacity (steering) @ Rated RPM	5.7 GPM (21.7 L/min)	5.3 GPM (20.1 L/min)
Pump capacity (implement) @ Rated	10.1 GPM (38.3 L/min)	9.4 GPM (35.5 L/min)
3-point hitch	Category 1	
Control	Position control, open center	
3-point lift capacity (standard)	3,307 lbf (1500 kgf)	
3-point lift capacity at 24" (61 cm)	2,756 lbf (1250 kgf)	
4-way loader control valve	Standard	
Power steering	Fully hydraulic	

## Traveling Speeds

Forward (with R1 tires)	0 – 18 mph (0 – 29 kmh)
Reverse (with R1 tires)	0 – 18 mph (0 – 29 kmh)

## Tire Size

Front	R1	8" – 16"	Rear	R1	14.9" – 24"
	R3	27" x 10.5" – 15"		R3	44" x 18" – 20"
	R4	10" – 16.5"		R4	17.5" L – 24"

## Features and Options

A/B mode	Standard	Rear remote	2 Standard (+1 option)
Auto throttle	Standard	Loader control valve & joystick	Standard
Anti-stall	Standard	Loader 3rd function valve	Optional
Throttle boost	Standard	Radio kit	Optional
Cruise control	Standard	12V outlet	Standard

## B90 Backhoe

Maximum digging depth	110" (2794 mm)
Digging depth (2' flat bottom)	109" (2769 mm)
Swing arc	180°
Loading height (bucket at 60°)	89" (2261 mm)
Transport height (maximum)	97" (2464 mm)
Bucket rotation	180°
Loading reach (bucket at 60°)	57" (1448 mm)
Stabilizer spread – up position	66" (1676 mm)
Stabilizer spread – down position	100" (2540 mm)
Bucket cylinder digging force	*5,070 lbf (2299 kgf)
Dipperstick cylinder digging force	*2,900 lbf (1315 kgf)
Operating pressure	*2,500 PSI (17.2 MPa)
Ramp angle (with industrial tires)	18°
Street pads	Optional
Bucket options	Various 12" – 36" (200 – 400 mm)
Weight	Approx. shipping weight (frame only) 1,365 lbs. (619 kg)

\*Based on backhoe manufacturers relief setting

†See your local YANMAR Independent Dealer for warranty coverage and any details.

## YL610 Loader (YL610 specifications based on YT359 R4 configuration)

Maximum lift height (to bucket pivot pin)	113" (2870 mm)
Maximum lift height at bottom of bucket	105.5" (2680 mm)
Reach with attachment on ground	74" (1880 mm)
Overall height in carry position	55.9" (1420 mm)
Dump clearance	88" (2235 mm)
Dump reach at maximum lift height	15" (376 mm)
Maximum dump angle	45°
Bucket rollback angle	40°
Digging depth at bucket level	7.5" (190.5 mm)
Bucket width	72" (1829 mm)
Lift capacity at pivot pins	2,500 lbs. (1134 kg)
Lift capacity at 500 mm forward of the pivot pins	1,795 lbs. (814 kg)
Breakout force 500 mm forward of the pivot pins	3,047 lbs. (1382 kg)
Breakout force at pivot pins	3,969 lbs. (1800 kg)
Raising time to full height without load	4.6 sec.
Lowering time without load (power down)	3.1 sec.
Bucket dumping time	1.6 sec.
Bucket rollback time	2.8 sec.
Rated flow	9.4 GPM (35.5 L/min)
Relief valve	2,422 PSI (16.7 MPa)
Bucket capacity	10.9 cu. ft. (0.309 m <sup>3</sup> )
Bucket weight	319 lbs. (145 kg)
Loader weight without bucket	776 lbs. (352 kg)
Loader valve and grille guard	Standard





Note: Attachments sold separately. Please see your local dealer for details.

## Warranty Coverage for Your Tractor †

Tractor (private individual usage)	24 months or 2,000 hours
Power train (Engine and transmission core components)	10 years or 3,000 hours
Attachments	1-year limited warranty

TO LEARN MORE ABOUT  
THE YT347/359  
PLEASE VISIT  
YANMARTRACTOR.COM

Connect with the YANMAR America community to share your stories, photos and videos.

-  <https://www.facebook.com/yanmartractoramerica>
-  <https://www.instagram.com/yanmaramerica>
-  <https://www.linkedin.com/showcase/yanmar-tractor>
-  <https://www.youtube.com/user/yanmarusa>

YANMAR America Corporation  
101 International Pkwy, Adairsville, GA 30103  
770.877.9894

[www.YANMARtractor.com](http://www.YANMARtractor.com)

The information in this brochure is accurate as of the date of printing and subject to change. All rights reserved by and belong to YANMAR®.  
©2022 YANMAR America Corporation. YT22-174 03/24

YANMAR has a corporate policy of continuous product improvement and development; therefore data, specifications, and warranty are subject to change without any advance notice. There may be differences between the specifications and illustrations contained in this publication and the actual equipment. Equipment components produced by other manufacturers may be shown in photographs in this publication for the purpose of illustration only and is not intended as an endorsement of that particular equipment or its suitability. Inspect equipment before using it and be sure it is operating properly. The product depictions are not meant to be used or relied upon as a substitute for the safety and use information that is published in the respective operator's manual. Before operating a machine, read, understand, and follow all instructions of the manual and on the machine. YANMAR disclaims all representations, express or implied, or any liability from the use of this publication.